

PRODUCT DESCRIPTION

RF-Capacitance /Admittance level switch is appropriate to be applied in liquid and solid mediums. It is designed to resist possible medium attachments. This product also offers DPDT output, high/low level failsafe, adjustable time delay, and sensitivity adjustment. Offer of various models is available for high temperature, or limited space environment.

FEATURES

- Anti-Viscosity
- Easy Installation
- Stable; Not affected by temperature
- Time delay function from 0-30 seconds
- IP65 housing protection
- 5 A/250Vac output DPDT
- Highest temperature tolerance of 450°C
- High/low failsafe
- Applicable in liquid, syrup, solid, powder, and interface detection
- Alarm testing

PRINCIPLE

RF-Capacitance /Admittance level switch consists of guard section, active section, grounding, and insulation. The guard section is designed to overcome possible medium attachment and to secure signal accuracy. The special structure is suitable for detecting in different medium without being affected by attachments.

Active section probe, guard, and grounding are insulated with insulation. Level of medium can be detected by increase of admittance when medium reaches the active section probe. Ground and active section probe are insulated, thus detection would not be wrongfully occurred to cause false alarm when medium attaches to the probe.

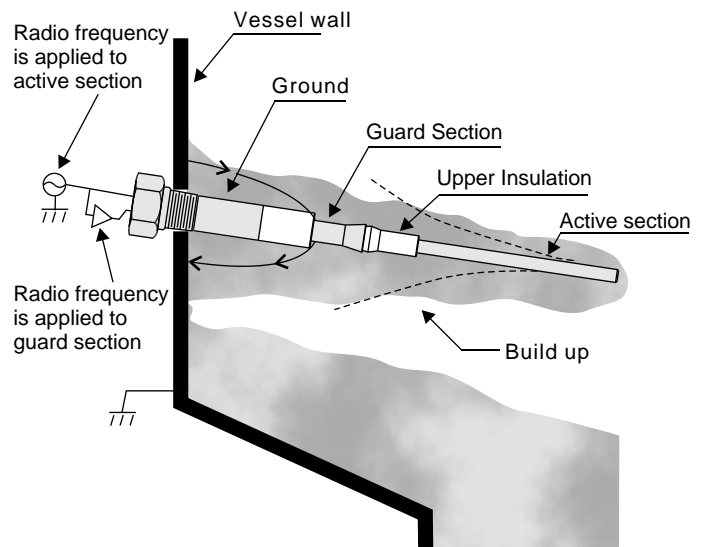

CONSTRUCTION & APPLICATION

CONSTRUCTION

1. Active Section: Made of SUS304 or SUS316
2. Upper Insulation: Insulation of Active Section and Guard Section, having very low die-electric constant and is made of PTFE or PEEK
3. Guard Section: Conductive metal probe to dissipate any possible presence of false signal.
4. Lower Insulation: Active Section probe having very low die-electric constant and is made of PTFE
5. Connection: 3/4"PT (Standard model)
6. Housing: Aluminum Alloy Spray Paint
7. Wiring Point: 1/2" NPT
8. Waterproof O-Ring: Rubber
9. Circuitry: FSH and FSL, Time Delay Adjustable Function
10. Housing Cover: Aluminum Alloy Spray Paint

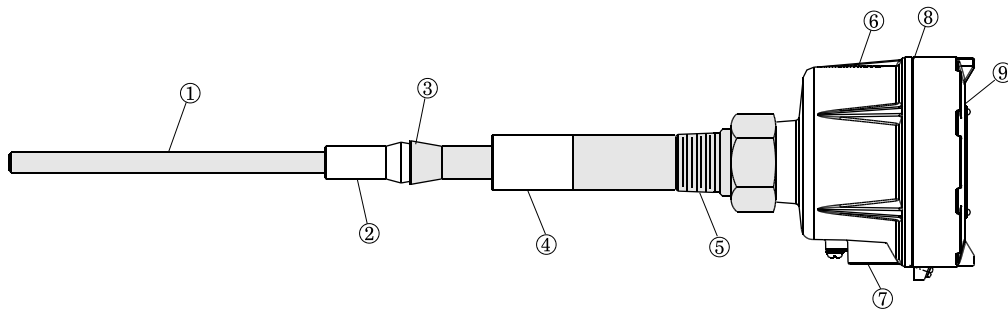

APPLICATION

Settlement Tank, Well, Reservoir, Medical Tank, Acidic Tank and various liquid, powder, pellet for precise level detection and control.

- | | |
|-----------------------------|---|
| ■ Brewery Plant | ■ Mining Plant |
| ■ Paint Manufacturing Plant | ■ Paper Manufacturing Plant |
| ■ Cement Plant | ■ Medical Plant |
| ■ Coal Plant | ■ Power Plant |
| ■ Food Processing Plant | ■ Water and Waste Water Treatment Plant |
| ■ Flour Mill | ■ Tar Factory |
| ■ Glass Industry | ■ Beverage Plant |
| ■ Plastic Plant | |

EXAMPLE

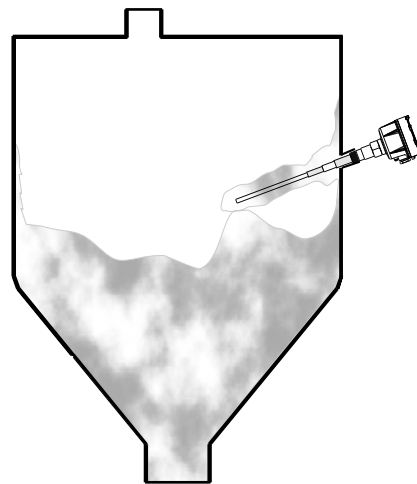

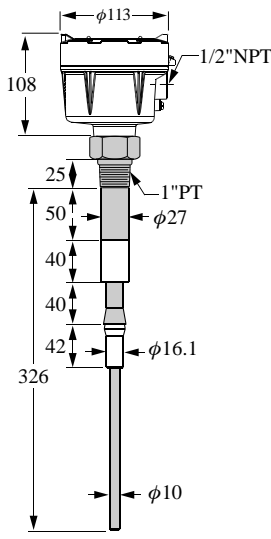
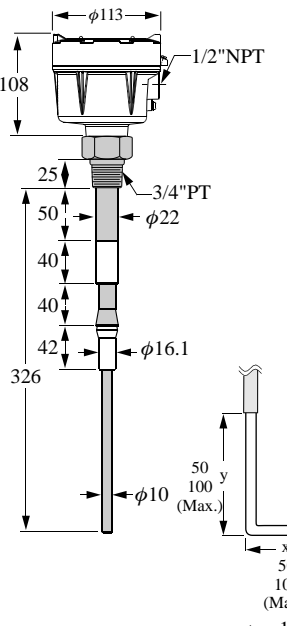
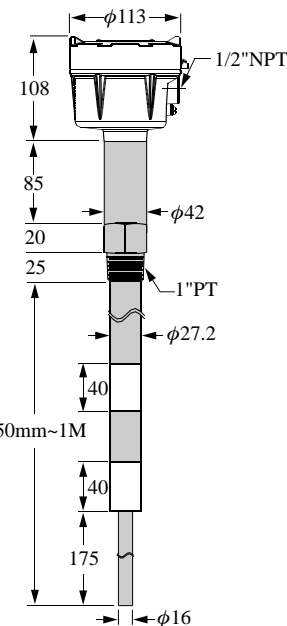

- 2100/2110: Standard Model ----- Applicable to normal environment.
 22000: Hi-Temp Model ----- Applicable to high temperature environment.
 2280: Super Hi-Temp Model ----- Applicable to super high temperature environment.
 2500: Cable Model ----- Applicable to big tank and top installation environment.
 2600: Mini Model ----- Applicable to space constraint and small tank.
 17□□: Explosion Proof Type ----- EEx d IIB T1~T6

SPECIFICATION

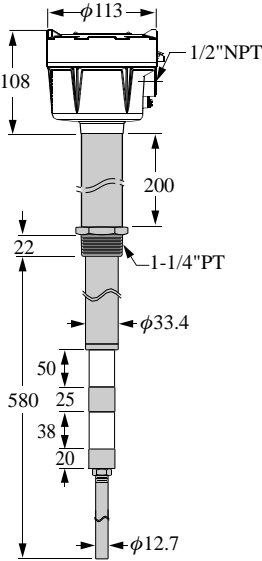
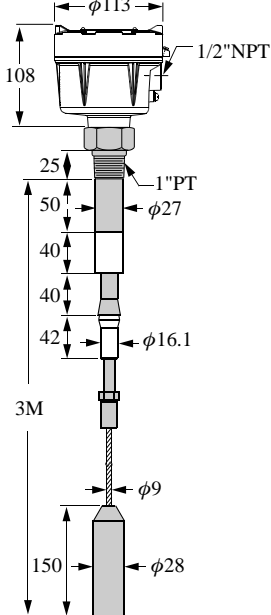
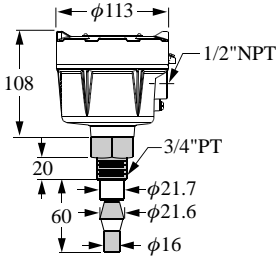



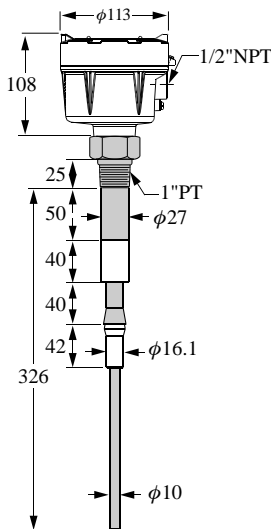
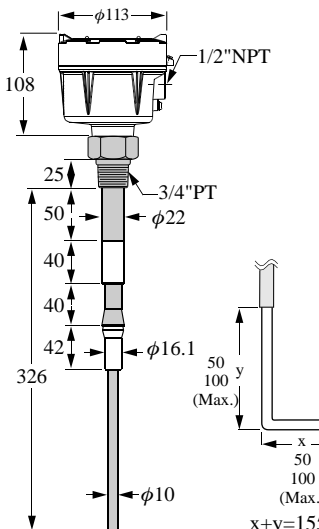
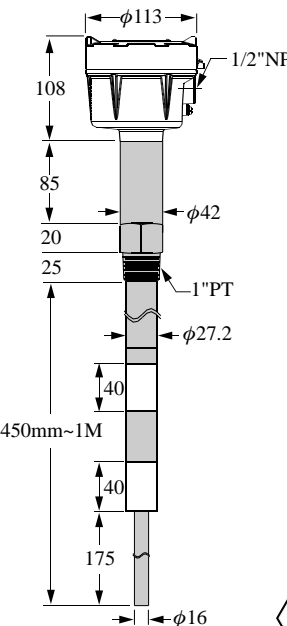

Dimension (Unit:mm)			
Order No.	SB2100 [Standard Type]	SB2110 [Standard Type] SB2120 [Standard L Type]	SB2200 [Hi-Temp Type]
Operating Temp.	-40°C~150°C	-40°C~150°C	-40°C~232°C
Ambient Temp.	-40°C~70°C	-40°C~70°C	-40°C~70°C
Housing	Aluminum (IP65)	Aluminum (IP65)	Aluminum (IP65)
Probe Material	SUS304 or 316	SUS304 or 316	SUS304 or 316
Insulated Material	PTFE	PTFE	PEEK
Connection	1" PT	3/4" PT	1" PT
Sensitivity	0.3PF	0.3PF	0.3PF
Supply Voltage	24Vdc±20% or 115/230Vac±10%, 50/60Hz	24Vdc±20% or 115/230Vac±10%, 50/60Hz	24Vdc±20% or 115/230Vac±10%, 50/60Hz
Power Consumption	Max.2W	Max.2W	Max.2W
Contact Rating	5A/250Vac, DPDT	5A/250Vac, DPDT	5A/250Vac, DPDT
Delay Time	0~30 sec	0~30 sec	0~30 sec
Fail safe mode	High / low Fail safe mode	High / low Fail safe mode	High / low Fail safe mode
Conduit	1/2" NPT x2 hole	1/2" NPT x2 hole	1/2" NPT x2 hole
Operation Pressure	20kg/cm ²	20kg/cm ²	20kg/cm ²

Dimension (Unit:mm)			
Order No.	SB2280 [Super Hi-Temp Type]	SB2500 [Cable Type]	SB2600 [Mini Type]
Operating Temp.	-40°C~450°C	-40°C~150°C	-40°C~150°C
Ambient Temp.	-40°C~70°C	-40°C~70°C	-40°C~70°C
Housing	Aluminum (IP65)	Aluminum (IP65)	Aluminum (IP65)
Probe Material	SUS304 or 316	SUS304 or 316	SUS304 or 316
Insulated Material	Ceramic	PTFE	PTFE
Connection	1-1/4" PT	1" PT	3/4" PT
Sensitivity	0.3PF	0.3PF	0.3PF
Supply Voltage	24Vdc±20% or 115/230Vac±10%, 50/60Hz	24Vdc±20% or 115/230Vac±10%, 50/60Hz	24Vdc±20% or 115/230Vac±10%, 50/60Hz
Power Consumption	Max.2W	Max.2W	Max.2W
Contact Rating	5A/250Vac, DPDT	5A/250Vac, DPDT	5A/250Vac, DPDT
Delay Time	0~30 sec	0~30 sec	0~30 sec
Fail safe mode	High / low Fail safe mode	High / low Fail safe mode	High / low Fail safe mode
Conduit	1/2" NPT x2 hole	1/2" NPT x2 hole	1/2" NPT x2 hole
Operation Pressure	ATM	20kg/cm ²	20kg/cm ²

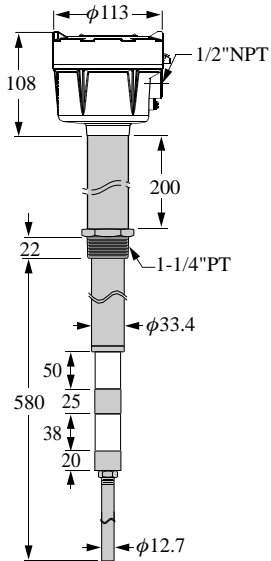
SPECIFICATION

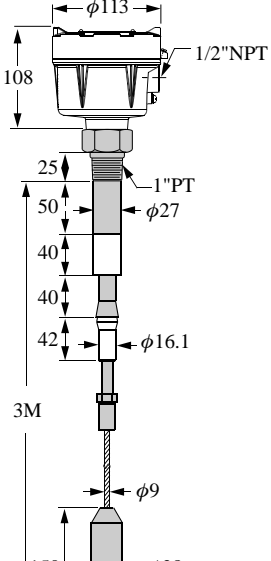
PTB PROOF NO. 09 ATEX 1057  II 2G EEx d IIB T1~T6
 II 2D tD A21 IP65 T445°C

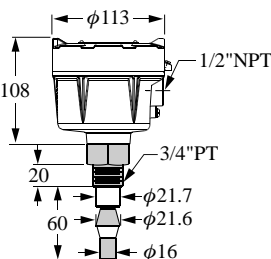
Dimension (Unit:mm)			
Order No.	SB1710 [Standard Type]	SB1720 [Standard Type] SB1730 [Standard L Type]	SB1770 [Hi-Temp Type]
Operating Temp.	-40°C~150°C	-40°C~150°C	-40°C~232°C
Ambient Temp.	-20°C~70°C	-20°C~70°C	-20°C~70°C
Housing	Aluminum (IP65)	Aluminum (IP65)	Aluminum (IP65)
Probe Material	SUS304 or 316	SUS304 or 316	SUS304 or 316
Insulated Material	PTFE	PTFE	PEEK
Connection	1" PT	3/4" PT	1" PT
Sensitivity	0.3PF	0.3PF	0.3PF
Supply Voltage	24Vdc±20% or 115/230Vac±10%, 50/60Hz	24Vdc±20% or 115/230Vac±10%, 50/60Hz	24Vdc±20% or 115/230Vac±10%, 50/60Hz
Power Consumption	Max.2W	Max.2W	Max.2W
Contact Rating	3A/250Vac, DPDT	3A/250Vac, DPDT	3A/250Vac, DPDT
Delay Time	0~30 sec	0~30 sec	0~30 sec
Fail safe mode	High / low Fail safe mode	High / low Fail safe mode	High / low Fail safe mode
Conduit	1/2" NPT x2 hole	1/2" NPT x2 hole	1/2" NPT x2 hole
Operation Pressure	20kg/cm ²	20kg/cm ²	20kg/cm ²

Dimension (Unit:mm)	 	 	 
Order No.	SB1728 [Super Hi-Temp Type]	SB1750 [Cable Type]	SB1760 [Mini Type]
Operating Temp.	-40°C~450°C	-40°C~150°C	-40°C~150°C
Ambient Temp.	-20°C~70°C	-20°C~70°C	-20°C~70°C
Housing	Aluminum (IP65)	Aluminum (IP65)	Aluminum (IP65)
Probe Material	SUS304 or 316	SUS304 or 316	SUS304 or 316
Insulated Material	Ceramic	PTFE	PTFE
Connection	1-1/4" PT	1" PT	3/4" PT
Sensitivity	0.3PF	0.3PF	0.3PF
Supply Voltage	24Vdc±20% or 115/230Vac±10%, 50/60Hz	24Vdc±20% or 115/230Vac±10%, 50/60Hz	24Vdc±20% or 115/230Vac±10%, 50/60Hz
Power Consumption	Max.2W	Max.2W	Max.2W
Contact Rating	3A/250Vac, DPDT	3A/250Vac, DPDT	3A/250Vac, DPDT
Delay Time	0~30 sec	0~30 sec	0~30 sec
Fail safe mode	High / low Fail safe mode	High / low Fail safe mode	High / low Fail safe mode
Conduit	1/2" NPT x2 hole	1/2" NPT x2 hole	1/2" NPT x2 hole
Operation Pressure	ATM	20kg/cm ²	20kg/cm ²

WIRING DIAGRAM

DESCRIPTION OF PANEL FUNCTION

- ① Set Point: Clockwise, capacitance increases.
- ② Red LED: Power indicator.
- ③ Range: Alarm setting- HI/LOW
- ④ FSH/FSL switch (High/Low level failsafe)
- ⑤ Green LED: Alarm indicator for FSH and FSL.
Green LED turns off when alarm goes off.
- ⑥ Time Delay: Alarm time delay setting up to 30 seconds.
- ⑦ Alarm simulation testing.(SB2□□□A series)
- ⑧ Relay output.
- ⑨ Power: 115/230Vac

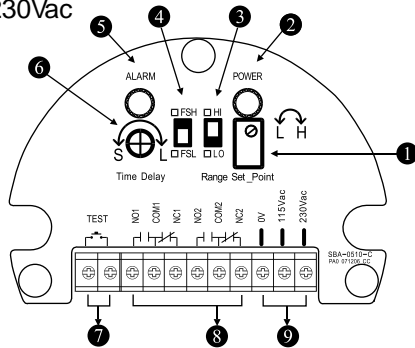

FAILSAFE ALARM

FSH high level failsafe alarm:

SB2□□□ Switch is installed in high level and FSH mode is on. Green LED lights up and relay output COM/NC is opened when medium is in normal level(Medium does not reach the probe). When medium level reaches high level(Medium touches the probe) or blackout, Green LED shuts off and relay output COM/NC is closed. When relay output COM/NC is closed, it implies FSH alarm is activated.

CALIBRATION

Setting for High Level Alarm

- 1.Switch the FSH/FSL Knob to FSH
- 2.Switch the Range Knob to LO.
- 3.Switch the Time Delay Knob to S (Minimum).
- 4.Decreasing the level of the medium to below the measuring probe.
- 5.Spining the Set Point Knob till the Alarm LED (green light) lights up.
- 6.Firstly, increasing the level of the medium till it covers half of the measuring probe and the Alarm LED (green light) shut off. Secondly, spinning the Set Point Knob clockwise till Alarm LED (green light) lights up. If the Alarm LED (green light) still not lights up after spinning it till the end, please adjust the Range Switch to HI and repeat procedure 5. Thirdly, recording the numbers of turns and its angle, then switching the knob counterclockwise back for 1/2 circle and angle.
- 7.Adjusting the delay time for alarm (0~30 seconds):
If turning the Time Delay Knob clockwise, the delay time is postponed, while turning the Time delay Knob counterclockwise, the delay time is shorten.

DESCRIPTION OF PANEL FUNCTION

- ① Set Point: Clockwise, capacitance increases.
- ② Red LED: Power indicator.
- ③ Range: Alarm setting- HI/LOW
- ④ FSH/FSL switch (High/Low level failsafe)
- ⑤ Green LED: Alarm indicator for FSH and FSL.
Green LED turns off when alarm goes off.
- ⑥ Time Delay: Alarm time delay setting up to 30 seconds.
- ⑦ Alarm simulation testing.(SB2□□□B series)
- ⑧ Relay output.
- ⑨ Power: 24Vdc.

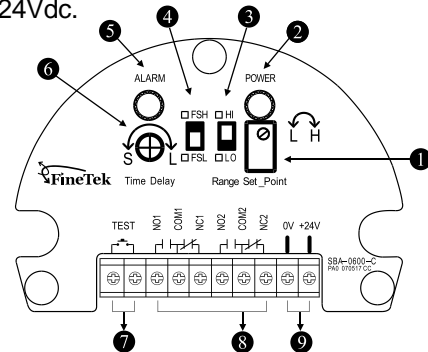

FSL low level failsafe alarm:

SB2□□□ series Switch is installed in low level and FSL mode is on. Green LED lights up and relay output COM/NC is opened when medium is in normal level(Medium touches the probe). When medium level drops below low level(Medium does not reach the probe) or blackout, Green LED shuts off and relay output COM/NC is closed. When relay output COM/NC is closed, it implies FSL alarm is activated.

Setting for Low Level Alarm

- 1.Switch the FSH/FSL Knob to FSL.
- 2.Switch the Range Knob to LO.
- 3.Switch the Time Delay Knob to S (Minimum).
- 4.Increasing the level of the medium to cover half of the measuring probe.
- 5.Spining the Set Point Knob counterclockwise till the Alarm LED lights up. If the LED doesn't light up after spinning it to the end, please adjust the Range Knob to HI and repeat procedure 5.
- 6.Firstly, decreasing the level of the medium till it is below the measuring probe and the Alarm LED shut off. Secondly, spinning the Set Point Knob counterclockwise till Alarm LED (green light) lights up. Thirdly, recording the numbers of turns and its angle, then switching the knob clockwise back for 1/2 circle and angle.
- 7.Adjusting the delay time for alarm (0~30 seconds):
If turning the Time Delay Knob clockwise, the delay time is postponed, while turning the Time delay Knob counterclockwise, the delay time is shorten.

ORDER INFORMATION

SB 2

Order No. _____

- 10: Standard Type (1"PT)
- 11/12: Standard Type/Standard L Type (3/4"PT)
- 20: Hi-Temp Type (232°C)
- 28: Super Hi-Temp Type (450°C)
- 50: Cable Type
- 60: Mini Type

MATERIAL _____

- 0: SUS304 6: SUS316 L: SUS316L

POWER _____

- A: 110/220Vac ± 10%, 50/60Hz---to have Remote test
- B: 24Vdc ± 20%---to have Remote test
- C: 115/230Vac ± 10%, 50/60Hz
- D: 24Vdc ± 20%

Connection _____

Dimension	Specification	
C---3/4"(20A)*	M---5kg/cm ²	Q---PT
D---1"(25A)	N---10kg/cm ²	R---PF
E---1-1/2"(40A)	O---150 Lbs	T---BSP
F---2"(50A)	P---300 Lbs	U---NPT
G---2-1/2"(65A)	W---PN 10	V---GAS
H---3"(80A)	X---PN 16	S---Others
I ---4"(100A)	Y---PN 25	
J ---5"(125A)	Z---PN 40	
K---6"(150A)	3---1-1/4"(32A)	
S---Others	*3/4" connection is only available for SB2100, 2110, 2120, 2600.	

Probe Length (unit: mm) _____

- 0500: below 500mm
- 1000: 501~1000mm
- 1500: 1001~1500mm
- ⋮
- ⋮

- ※ 500mm per Unit
- ※ Use English letter as first code for probe length over 10m.
A150 represents 15m, A200 represents 20m

- * Tolerance of the total product length is ±5mm.
- * Characteristics, specifications and dimensions are subject to change without notice.
- * Please contact your nearest distributing office for further informations.

ORDER INFORMATION

SB17

Order No. _____

- 10: Explosion Proof Standard Type(1"PT)
- 11/12: Explosion Proof Standard Type /Standard L Type (3/4"PT)
- 20: Explosion Proof Hi-Temp Type (232°C)
- 28: Explosion Proof Super Hi-Temp Type (450°C)
- 50: Explosion Proof Cable Type
- 60: Explosion Proof Mini Type

MATERIAL _____

0: SUS304 6: SUS316 L: SUS316L

POWER _____

- A: 110/220Vac ± 10%, 50/60Hz---to have Remote test
- B: 24Vdc ± 20%---to have Remote test
- C: 115/230Vac ± 10%, 50/60Hz
- D: 24Vdc ± 20%

Connection _____

Dimension	Specification	
C---3/4"(20A)*	M---5kg/cm ²	Q---PT
D---1"(25A)	N---10kg/cm ²	R---PF
E---1-1/2"(40A)	O---150 Lbs	T---BSP
F---2"(50A)	P---300 Lbs	U---NPT
G---2-1/2"(65A)	W---PN 10	V---GAS
H---3"(80A)	X---PN 16	S---Others
I ---4"(100A)	Y---PN 25	
J ---5"(125A)	Z---PN 40	
K---6"(150A)	3---1-1/4"(32A)	
S---Others	*3/4" connection is only available for SB2100, 2110, 2120, 2600.	

Probe Length (unit: mm) _____

- 0500: below 500mm
- 1000: 501~1000mm
- 1500: 1001~1500mm
- ⋮
- ⋮

- ※ 500mm per Unit
- ※ Use English letter as first code for probe length over 10m.
A150 represents 15m, A200 represents 20m

- * Tolerance of the total product length is ±5mm.
- * Characteristics, specifications and dimensions are subject to change without notice.
- * Please contact your nearest distributing office for further informations.