



Vibrating Probe Level Switch

PRODUCT INTRODUCTION

WORKING PRINCIPLE

The vibrating probe of level switch operated by using two piezoelectric elements built-in on vibration tube. The first piezoelectric element triggered by pulse signal that created from circuit to transport vibration energy out, and the other piezoelectric element receives the vibration and transmits it to output electric signal. While the probe contacts material, the detection signal will be decayed and the vibration will hold and send out the relay on. Vibrating probe of level switch provides reliable & maintenance-free for bulk solids. Just a simple mounting and calibration procedure that keep your facility in save and monitoring. This device can withstand fiercely lateral loads and static electricity. For friendly use, Fail-safe is equipped as standard to prevent malfunction caused by power shortage.

FEATURE

- Glass window, to review power supply and output directly without having to take off enclosure cover (SC3 series).
- Dual insulation can reduce damage on PCB board caused by temperature, humidity, and condensation effects.
- Wide voltage supply range 20~250, 50~60Hz Vac/ Vdc
- SPDT Relay output, SSR MOSFET output.
- No calibration required, easy use, sturdy and durable design.
- Avoid media accumulation on probe.
- High/ Low failure safe modes.
- Sensitivity adjustment is available for different density of media. Fine powder can be detected.
- Interface detection between solid liquid is available.
- Strong vibration force, suitable for powder and solid applications.

APPLICATION

- Most materials in powder can be detected, includes coffee, milk powder, chocolate, coal ash, bulk, sugar, salt, wheat, grains, glass debris, plastic pellet, cement
- Sludge level detection in waste water

- Powdered milk
- Frozen potato chips
- Beans
- Sugar
- Sweets
- Coffee beans
- Coffee Powder
- Tea (leaf)
- Salt
- Flour
- Foundry sand
- Spices
- Animal food
- Pellets
- Peanuts
- Tobacco
- Wood shavings
- Chalk
- Stearin chips
- Powdered cellulose
- Glass finely poeder
- Granular plastics
- Gravel
- Powdered clay
- Polystyrene powder
- Styrofoam
- Soda
- Soot dry

Structure & Dimension

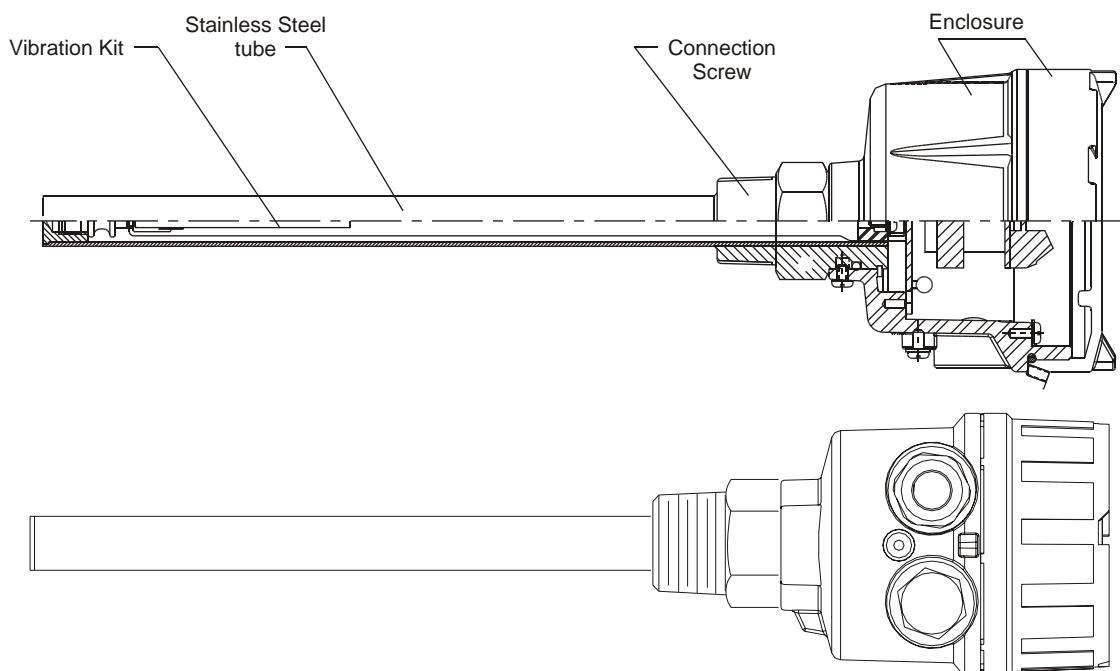

SPECIFICATION (Multi-Function Vibrating Probe Level Switch)

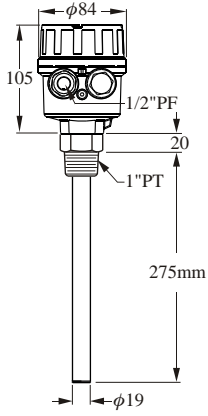
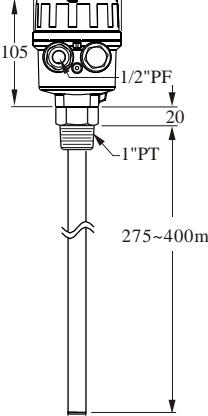
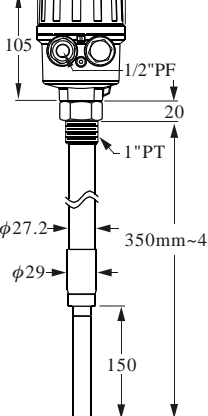
Dimensions (Unit:mm)			
Order No.	SC3100 【 Standard Type 】	SC3110 【 Probe Extension Type 】	SC3120 【 Ultra Extension Type 】
Level Sensor Housing	Aluminum / IP65		
Probe Construction	SUS 304 / 316		
Mounting	1"PT		
Conduit	1/2"NPT × 2		
Max. Vertical load on rod.	177in.Lbs(20Nm)		
Operating Pressure.	-1~150PSI (10BAR)		
Power Supply	20~250, 50/60Hz Vac/ Vdc		
Power Consumption	15VA (Max.)		
Operating Temp. In Ambient Air	-40°C~60°C		
Operating Temp. In Bin	-40°C~80°C		
Signal Output	Relay, SPDT, 5A/250Vac, PNP/NPN(MOSFET) 400mA/60 Vac/ Vdc		
Min. material density sensed	Solid: ≥0.32g/cm ³		
Time Delay	0.6~1 Second / Operate; 2~5 Seconds / Reset		
Vibrating Frequency.	395~405HZ		
Selectable Fail-safe	Hi./ Lo.		
Selectable Sensitivity	Hi./ Mid. / Lo.		

SPECIFICATION (Multi-Function Vibrating Probe Level Switch)

Dimensions (Unit:mm)			
Order No.	SC3300 【Cable Extension Type】	SC3500 【Corrosion Proof Type】	SC2510 【Corrosion Proof & Extension Type】
Level Sensor Housing	Aluminum / IP65		
Probe Construction	SUS 304 / 316	SUS 304/316 Coating TEFLON	SUS 304/316 Coating TEFLON
Mounting	1"PT	Flange 1"(min.)	Flange 1"(min.)
Conduit	1/2"PF × 2		
Max. Vertical load on rod.	177in.Lbs(20Nm)		
Operating Pressure.	-1~150PSI (10BAR)	-1~150PSI (10BAR)	-1~150PSI (10BAR)
Power Supply	20~250, 50/60Hz Vac/ Vdc		
Power Consumption	15VA (Max.)		
Operating Temp. In Ambient Air	-40°C~60°C		
Operating Temp. In Bin	-40°C~80°C		
Signal Output	Relay, SPDT, 5A/250Vac, PNP/NPN(MOSFET) 400mA/60 Vac/ Vdc		
Min. material density sensed	Solid: ≥0.32g/cm ³		
Time Delay	0.6~1 Second / Operate; 2~5 Seconds / Reset		
Vibrating Frequency.	395~405HZ		
Selectable Fail-safe	Hi./ Lo.		
Selectable Sensitivity	Hi./ Mid. / Lo.		

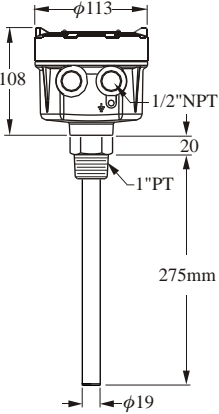
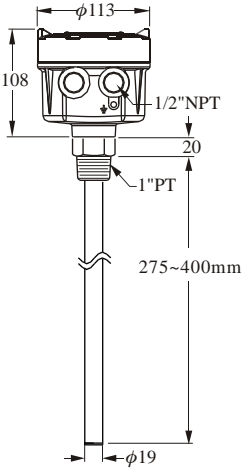
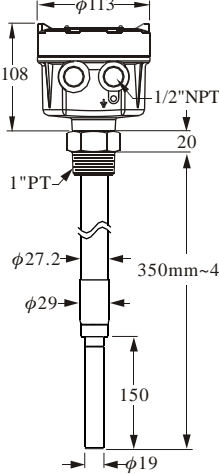

SPECIFICATION

Dimensions (Unit:mm)			
Order No.	SC2100 【Standard Type】	SC2110 【Probe Extension Type】	SC2120 【Ultra Extension Type】
Level Sensor Housing	Aluminum / IP65		
Probe Construction	SUS 304 / 316		
Mounting	1"PT		
Conduit	1/2"NPT × 2		
Max. Vertical load on rod.	177in.Lbs(20Nm)		
Operating Pressure.	-1~150PSI (10BAR)		
Power Supply	20~250, 50/60Hz Vac/ Vdc		
Power Consumption	15VA (Max.)		
Operating Temp. In Ambient Air	-40°C~60°C		
Operating Temp. In Bin	-40°C~80°C		
Signal Output	Relay, SPDT, 5A/250Vac, PNP/NPN(MOSFET)400mA/60 Vac/ Vdc		
Min. material density sensed	Solid: ≥0.32g/cm ³		
Time Delay	0.6~1 Second / Operate; 2~5 Seconds / Reset		
Remote-test	Yes		
Vibrating Frequency.	395~405HZ		
Selectable Fail-safe	Hi./ Lo.		
Selectable Sensitivity	Hi./ Mid. / Lo.		

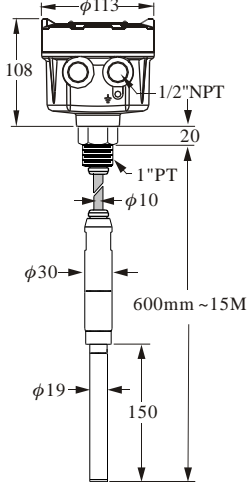
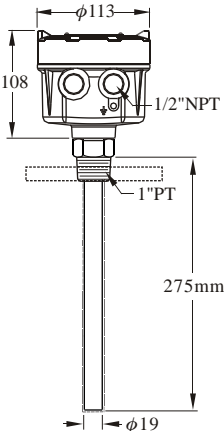
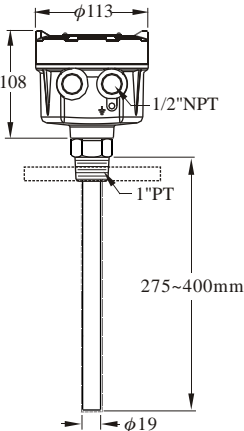
SPECIFICATION

<p>Dimensions (Unit:mm)</p>			
<p>Order No.</p>	<p>SC2300 【Cable Extension Type】</p>	<p>SC2500 【Corrosion-Proof】</p>	<p>SC2510 【Corrosion-Proof & Extension Typ】</p>
<p>Level Sensor Housing</p>	<p>Aluminum / IP65</p>		
<p>Probe Construction</p>	<p>SUS 304 / 316</p>	<p>SUS 304/316 Coating TEFLON</p>	<p>SUS 304/316 Coating TEFLON</p>
<p>Mounting</p>	<p>1"PT</p>	<p>Flange 1"(min.)</p>	<p>Flange 1"(min.)</p>
<p>Conduit</p>	<p>1/2"NPT × 2</p>		
<p>Max. Vertical load on rod.</p>	<p>177in.Lbs(20Nm)</p>		
<p>Operating Pressure.</p>	<p>-1~150PSI (10BAR)</p>	<p>-1~150PSI (10BAR)</p>	<p>-1~150PSI (10BAR)</p>
<p>Power Supply</p>	<p>20~250, 50/60Hz Vac/ Vdc</p>		
<p>Power Consumption</p>	<p>15VA (Max.)</p>		
<p>Operating Temp. In Ambient Air</p>	<p>-40°C~60°C</p>		
<p>Operating Temp. In Bin</p>	<p>-40°C~80°C</p>		
<p>Signal Output</p>	<p>Relay, SPDT, 5A/250Vac, PNP/NPN(MOSFET)400mA/60 Vac/ Vdc</p>		
<p>Min. material density sensed</p>	<p>Solid: ≥0.32g/cm³</p>		
<p>Time Delay</p>	<p>0.6~1 Second / Operate; 2~5 Seconds / Reset</p>		
<p>Remote-test</p>	<p>Yes</p>		
<p>Vibrating Frequency.</p>	<p>395~405HZ</p>		
<p>Selectable Fail-safe</p>	<p>Hi./ Lo.</p>		
<p>Selectable Sensitivity</p>	<p>Hi./ Mid. / Lo.</p>		

SPECIFICATION

NEPSI PROOF NO. GYJ06233 Ex d IIC T3~T6
 PTB PROOF NO. 05 ATEX 1026  II 2G EEx d IIB T6
 II 2D IP65 T6 85°C

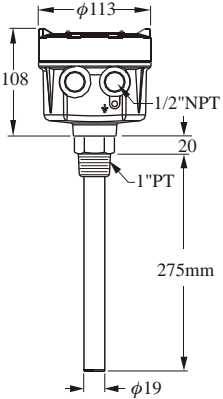
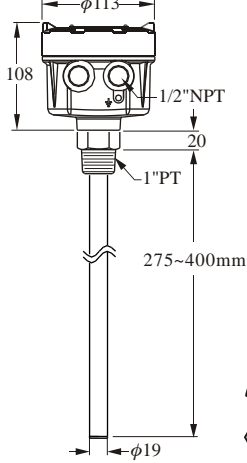
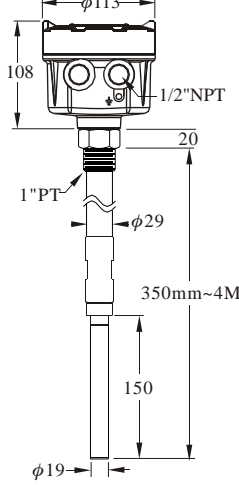
Dimensions (Unit:mm)	 <p style="text-align: center;">SC1700</p>	 <p style="text-align: center;">SC1701</p>	 <p style="text-align: center;">SC1710</p>
Order No.	SC1700 【 Standard Type 】	SC1701 【 Probe Extension Type 】	SC1710 【 Ultra Extension Type 】
Level Sensor Housing	Aluminum / Ex d IIC T3~T6		
Probe Construction	SUS 304 / 316		
Mounting	Screw: 1"PT or PF, Flange: 1"~6"JIS / DIN / ANSI		
Conduit	1/2"NPT×2		
Max. Vertical load on rod.	177in.Lbs(20Nm)		
Operating Pressure.	-1~150PSI (10BAR)		
Power Supply	20~250Vac/dc		
Power Consumption	15W		
Operating Temp. In Ambient Air	-40°C~60°C		
Operating Temp. In Bin	-40°C~80°C		
Signal Output	Relay, SPDT , 3A/250Vac Max.		
Min. material density sensed	Solid: ≥0.32g/cm ³		
Time Delay	0.6 Second / Operate; 2~5 Seconds / Reset		
Vibrating Frequency.	395~405HZ		
Selectable Fail-safe	Hi./ Lo.		
Selectable Sensitivity	Hi./ Mid. / Lo.		

INSTALLATION

Vertical Installation (Figure 1):

1. It is suggested to install the vibrating probe away from the inlet to avoid material impact or false readings.
2. Users have to be aware of the material flow pattern and placing the vibrating probe in the appropriate position to avoid overflow.

Horizontal Installation (Figure 2)

1. It is suggested to install the vibrating probe away from the inlet to avoid of material impact. If it has to install the vibrating probe near an inlet, it is recommended to add a shield for protection.
2. Installing the vibrating probe at 20 degree inclined will optimize the result and increase the sensitivity.
3. Keep the conduit downward to avoid moisture getting inside the housing.

Notice:

1. Please DO NOT climb on the vibrating probe while installation.
2. Users are advised to tighten the connection by using the spanner.
3. Please DO NOT bend the vibrating probe or modify the probe length.
4. The max. vertical pressure of the vibrating probe is 177in.Lbs (20Nm)

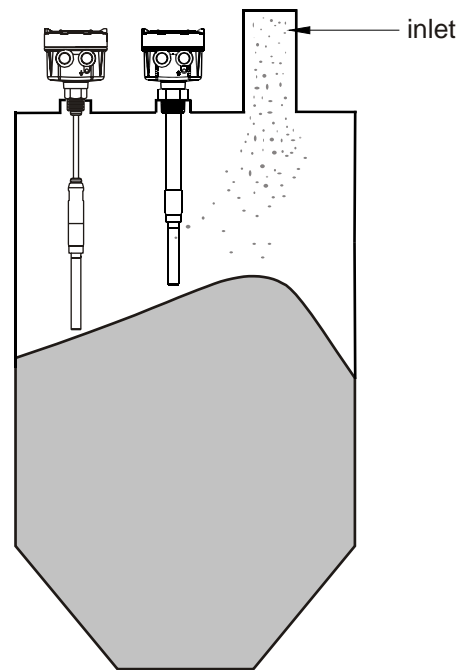

Figure 1

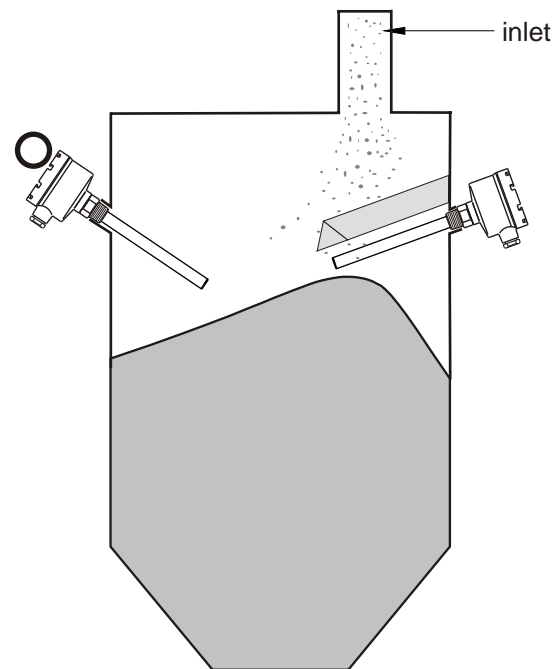
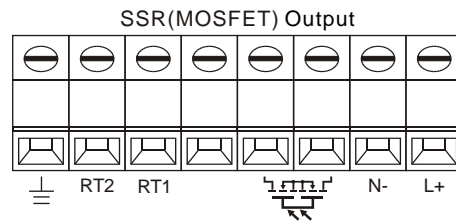
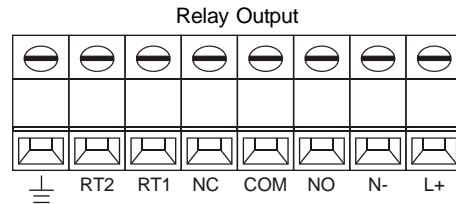
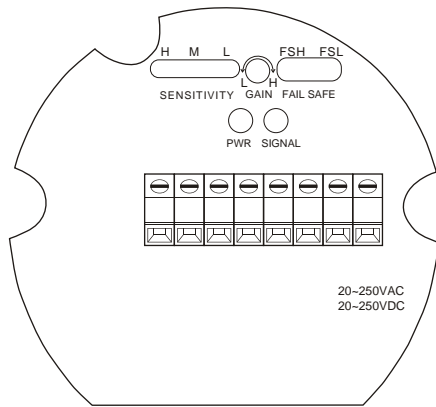

Figure 2

TERMINAL / SENSITIVITY ADJUSTMENT (EURO TYPE)

SC2100X, SC2110X, SC2200X, SC2210X, SC2300X, SC2500X, SC1700X, SC1701X, SC1710X



Terminal Function

- L+, N-: Power Supply
- NC, COM, NO: Relay Output
- RT1, RT2: Remote-Test
- \perp : Ground Connection
- : SSR (MOSFET) Output

Panel Function

- PWR: Power Supply (Green Light)
- SIGNAL: Output Indication (Red Light)
- FSH: Power On. The signal lamp is on and the relay is conductive. While the vibrating probe senses the material, the signal lamp is off and relay is not conductive.
- FSL: Power On. The signal lamp is off and the relay is not conductive. While the probe senses the material, the signal lamp is on and relay is conductive.
- SENSITIVITY L: Low Sensitivity
- SENSITIVITY H: High Sensitivity

Sensitivity Adjustment

1. GAIN: Located upside of PCB and not allow users to do the adjustment.
2. SENSITIVITY: Located above PCB. Three options (L.M.H) are offered for the adjustment. When switching to H position, it has the highest sensitivity. When switching to L position, it has the lowest sensitivity. The original setting is at L position and users are able to adjust the sensitivity depends on the specific gravity of material.

- H: High Sensitivity (Suitable for detecting low specific gravity material)
- M: Medium Sensitivity (Suitable for detecting medium specific gravity material)
- L : Low Sensitivity (Suitable for detecting low specific gravity material)

Fail-Safe High / Low Protection

FSH (Fail-Safe High) Protection:

Switch to FSH mode.

Normal Status: The signal lamp is on. It means that the vibrating probe does not sense the material and the relay is conductive.

Failure: When the power shuts down, the signal lamp is off. It means that the vibrating probe is voided and the relay is not conductive.

FSL (Fail-Safe Low) Protection:

Switch to FSL mode.

Normal Status: The signal lamp is on. The vibrating probe senses the material and the relay is conductive.

Failure: When the power shuts down, the signal lamp is off. The vibrating probe is voided and the relay is not conductive.

	FSL		FSH	
Level				
Contact Form				
Indication				
Status	Fail	Normal	Normal	Fail

TERMINAL / SENSITIVITY ADJUSTMENT (UL TYPE)

SC2100X, SC2110X, SC2200X, SC2210X, SC2300X, SC2500X, SC1700X, SC1701X, SC1710X

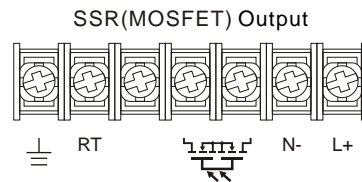
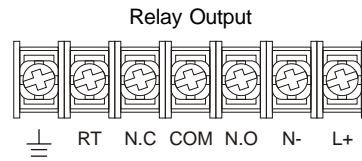
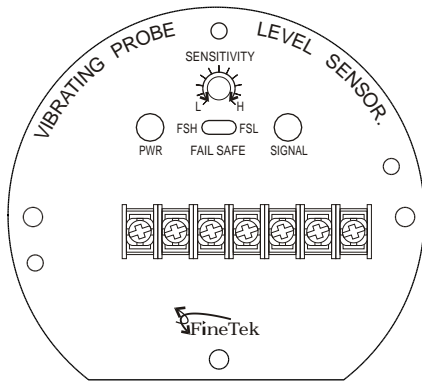

Terminal Function

- L+, N-: Power Supply
- NC, COM, No: Relay Output
- RT: Remote-Test
- \perp : Ground Connection
- : SSR(MOSFET) Output

Panel Function

- PWR: Power Supply (Green Light)
- SIGNAL: Output Indication (Red Light)
- FSH: Power On. The signal lamp is on and the relay is conductive. While the vibrating probe senses the material, the signal lamp is off and relay is not conductive.
- FSL: Power On. The signal lamp is off and the relay is not conductive. While the probe senses the material, the signal lamp is on and relay is conductive.
- SENSITIVITY L: Low Sensitivity
- SENSITIVITY H: High Sensitivity

Sensitivity Adjustment

1. SENSITIVITY: Located upside of PCB. When switching to H position, it has the highest sensitivity. When switching to L position, it has the lowest sensitivity. The original setting is at L position and users are able to adjust the sensitivity depends on the specific gravity of material.

- H: High Sensitivity (Suitable for detecting low specific gravity material)
- L : Low Sensitivity (Suitable for detecting low specific gravity material)

Fail-Safe High / Low Protection

FSH (Fail-Safe High) Protection:

Switch to FSH mode.

Normal Status: The signal lamp is on. It means that the vibrating probe does not sense the material and the relay is conductive.

Failure: When the power shuts down, the signal lamp is off. It means that the vibrating probe is voided and the relay is not conductive.

FSL (Fail-Safe Low) Protection:

Switch to FSL mode.

Normal Status: The signal lamp is on. The vibrating probe senses the material and the relay is conductive.

Failure: When the power shuts down, the signal lamp is off. The vibrating probe is voided and the relay is not conductive.

	FSL		FSH	
Level				
Contact Form				
Indication				
Status	Fail	Normal	Normal	Fail

TERMINAL / SENSITIVITY ADJUSTMENT (MULTI-FUNCTION TYPE)

SC3100X, SC3110X, SC3120X, SC3300X, SC3500X

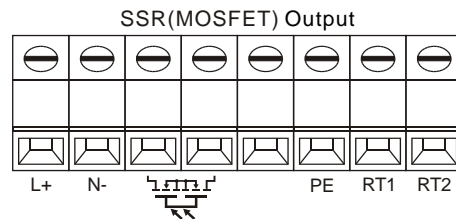
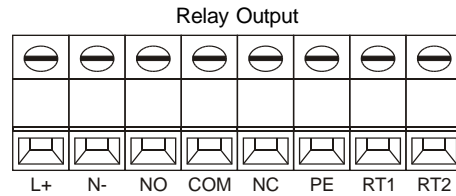
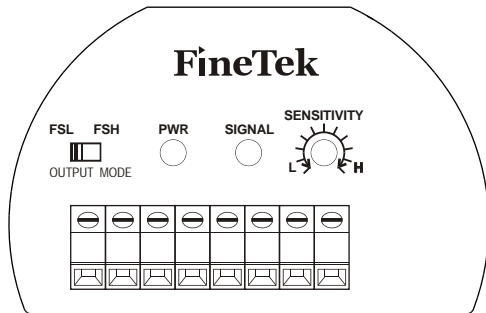

Terminal Function

- L+, N-: Power Supply
- NC, COM, No: Relay Output
- RT1, RT2: Remote-Test
- \equiv : Ground Connection
-  : SSR(MOSFET) Output

Panel Function

- PWR: Power Supply (Green Light)
- SIGNAL: Output Indication (Red Light)
- FSH: Power On. The signal lamp is on and the relay is conductive. While the vibrating probe senses the material, the signal lamp is off and relay is not conductive.
- FSL: Power On. The signal lamp is off and the relay is not conductive. While the probe senses the material, the signal lamp is on and relay is conductive.
- SENSITIVITY L: Low Sensitivity
- SENSITIVITY H: High Sensitivity

Sensitivity Adjustment

1. SENSITIVITY: Located upside of PCB. When switching to H position, it has the highest sensitivity. When switching to L position, it has the lowest sensitivity. The original setting is at L position and users are able to adjust the sensitivity depends on the specific gravity of material.

- H: High Sensitivity (Suitable for detecting low specific gravity material)
- L : Low Sensitivity (Suitable for detecting low specific gravity material)

Fail-Safe High / Low Protection

FSH (Fail-Safe High) Protection:

Switch to FSH mode.

Normal Status: The signal lamp is on. It means that the vibrating probe does not sense the material and the relay is conductive.





Failure: When the power shuts down, the signal lamp is off. It means that the vibrating probe is voided and the relay is not conductive.

FSL (Fail-Safe Low) Protection:

Switch to FSL mode.

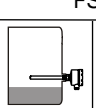
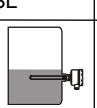
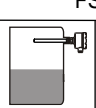
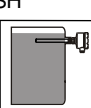
Normal Status: The signal lamp is on. The vibrating probe senses the material and the relay is conductive.

Failure: When the power shuts down, the signal lamp is off. The vibrating probe is voided and the relay is not conductive.

	FSL		FSH	
Level				
Contact Form				
Indication	○	☀	☀	○
Status	Fail	Normal	Normal	Fail

ORDER INFORMATION

SC () ()

ORDER NO.

- 3100: Multi-Function Vibrating Probe Standard Type
- 3110: Multi-Function Vibrating Probe Extension Type
- 3120: Multi-Function Vibrating Probe Ultra Extension Type
- 3300: Multi-Function Vibrating Probe Cable Extension Type
- 3500: Multi-Function Vibrating Probe Corrosion Proof Type
- 2100: Vibrating Probe Standard Type
- 2110: Vibrating Probe Extension Type
- 2120: Vibrating Probe Ultra Extension Type
- 2300: Vibrating Probe Cable Extension Type
- 2500: Vibrating Probe Corrosion Proof Type
- 1700: Explosion Proof Vibrating Probe Standard Type
- 1701: Explosion Proof Vibrating Probe Extension Type
- 1710: Explosion Proof Vibrating Probe Ultra Extension Type

POWER & OUTPUT MODULE

- 20~250Vac/ Vdc, 50/60Hz
- A: Relay O/P (Barrier terminal Block)(limited series of 17 and 21 series)
- B: Transistor PNP/NPN (Barrier terminal Block)(limited series of 17 and 21 series)
- R: Relay O/P (Green terminal)-EuroType
- N: Transistor PNP/NPN-EuroType

MATERIAL

0: SUS304 6: SUS316 P: PTFE

CONNECTION

Dimension	Specification
D---1"(25A)	M---5kg/cm ² Y---PN 25
3---1-1/4"(32A)	N---10kg/cm ² Z---PN 40
E---1-1/2"(40A)	O---150 Lbs S---others
F---2"(50A)	P---300 Lbs 9---Sanitary
G---2-1/2"(65A)	Q---PT
H---3"(80A)	R---PF(G)
I---4"(100A)	T---BSP
J---5"(125A)	U---NPT
K---6"(150A)	W---PN 10
S---others	X---PN 16

LENGTH (L) (UNIT: cm)

- 0500: below 500mm
- 1000: 501~1000mm
- 1500: 1001~1500mm

- ※ 500mm per Unit
- ※ Use English letter as first code for probe length over 10m.
A150 represents 15m, A200 represents 20m

BEFORE YOU ORDER

1. Please affirm the voltage.
2. Please affirm the mounting positions.
3. Please affirm the material specific gravity (S.G.) value.
4. Please affirm whether any bridge block or vibrating motor are attached onto the silo wall.

Tolerance of the total product length is 65mm
 Characteristics, specifications and dimensions are subject to change without notice.
 Please contact your nearest distributing office for further information.

EXAMPLES-OF-TANK-MOUNTING

- [FC/FD] Mini Float/Magnetic Float Level Switch
- [FG] Magnetic Float Level Transmitter
- [FF] Side Mounting Float Switch
- [FA/FB] Cable Float Level Switch
- [SP] Thermal Dispersion Flow Switch
- [SF] Paddle Flow Switch
- [SD] Optical Level Switch
- [SE] Rotary Paddle Level Switch
- [SA] Capacitance Level Switch
- [EC] Pressure Level Transmitter
- [LR] Loop Power Indicator
- [SC] Vibrating Probe Level Switch
- [SC] Tuning Fork Level Switch
- [EB] RF-Capacitance Level Transmitter
- [SB] RF-Capacitance / Admittance Level Switch
- [EG] Magnetostrictive Level Transmitter
- [EF] By-Pass Level Transmitter
- [MEF] Mini By-Pass Level Transmitter
- [EA] Ultrasonic Level Transmitter
- [JFR] FMCW Radar Level Transmitter
- [EE] Electromechanical Level Measuring System
- [ED] Speed Monitor
- [SRT/SRS] Conveyer Belt Misalignment Switch & Safety Cable Pull Switch
- [PB/PM] Microprocessor Based Bargraphic Display Scaling Meter
- [BRD/AE] Valve and Controller for Dust Collector System
- [BAS/BAH/BVP] Air Hammer
- [BVK/BVR/BVT] Pneumatic Vibrator

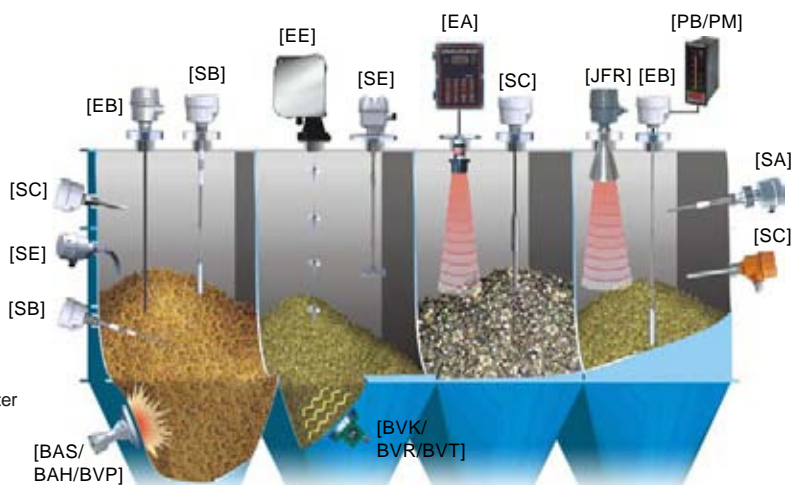
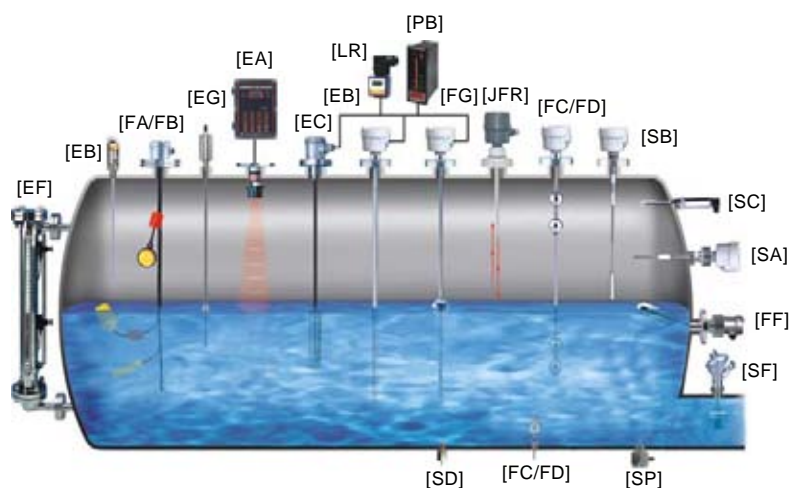

FineTek Co., Ltd.

No.16, Tzuchiang St., Tucheng Industrial Park Taipei Hsien, Taiwan.
 TEL: +886-2-2269-6789 FAX: +886-2-2268-6682
 Email: info@fine-tek.com

Fine automation (ShangHai) Co., Ltd.

No.451 DuHui Rd, MinHang District, Shanghai, China 201109
 TEL: +86-21-6490-7260 FAX: +86-21-6490-7276
 Email: info.sh@fine-tek.com

FineTek Pte Ltd.

No. 11 Kaki Bukit Road 1, #04-01 Eunos
 Technolink 415939, Singapore
 TEL: +65-6452-6340 FAX: +65-6734-1878
 Email: info.sg@fine-tek.com

FineTeK GmbH

Frankfurter Str. 62, OG D-65428 Ruesselsehim, Germany
 TEL: +49-(0)6142-17608-0 FAX: +49-(0)6142-17608-20
 E-Mail: info@fine-tek.de



Distributor:



Garma Electrónica, S.L.
 CIF: B-20178372
 CALLE OYARZUN, 1 bajo
 20013 SAN SEBASTIAN
 Tel. 943 29 11 02 · fax 943 27 35 77
 www.garmasl.com · garma@garmasl.com